

This user information presents a general overview regarding the application of textile lifting slings and does not substitute the existing operating instructions for specific products!

Lifting operations with textile slings may be carried out by competent users (trained in theory and practice) only.

When operated correctly, our textile slings offer the highest degree of safety in line with long life expectancy and avoid damage to products and people.

Limitations of use

Loading

Textile lifting slings must not be overloaded. The capacities for the most important lifting/sliding methods are indicated on the identity label. Always observe the maximum angle from the vertical (angle β)!

Temperature

Textile lifting slings made from polyester are admitted for applications at temperatures between -40° and $+100^{\circ}\text{C}$. This temperature area may change in chemical environments. The woven structure of the drenched textiles at temperatures below 0°C are susceptible to damage due to the formation of ice. Ice will reduce the flexibility of the lifting sling! At temperatures below 0°C , dry lifting equipment should be used only! In dry condition, polyester features a high electrical resistance and provides an insulating effect between load and crane hook (e.g. during welding jobs – observe temperatures!).

Shock loading

Textile lifting and lashing equipment should not be subjected to sharp jerks and jolts in order to avoid heavy forces which may be considerably higher than the actual load weight!

For information on training please see pages 4-5.

Chemicals

Particular caution is required when using textile lifting equipment in areas where chemicals are present.

Polyester has good resistance against mineral acids but will be destroyed by alkaline – consult our experts for advice in your specific application!

Acid may cause material brittleness to steel fittings of textile lifting slings! Harmless acid solutions may concentrate by evaporation to an extent that they provoke damages. Affected textile lifting equipment must be thoroughly rinsed in cold water, dried in open air and inspected by a competent person.

Transport of people

Transport of people with textile lifting equipment is generally forbidden!

Operation in danger zones

Lifting or transport of loads must be avoided while personnel are in the danger zone.

People are not allowed to pass over or under a suspended load!

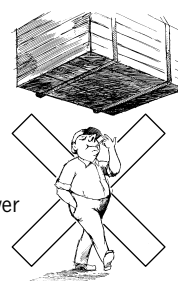

Application advices

- The operator may start moving the load only after it has been correctly attached and all personnel are clear of the danger zone.
- Loads must not be left unattended in raised or tensioned condition for a longer period of time.
- Flat webbing or round slings must not be used in knotted, tied or twisted condition and may only be used for the attachment of loads.
- Prior to every use, textile lifting and lashing equipment must be examined with regard to obvious defects. Ensure that their identity and dimensions are correct and that they are provided with a legible capacity label. Never use lifting equipment which is defective or not labelled!
- Damage of the capacity label can be avoided by keeping it away from the load, the hook or choke hitch operations.
- The angle of the eye must not exceed 20° in order to avoid inadmissible strain on the seams! This will be ensured when the eye length is approx. 4 times the width of the hook.

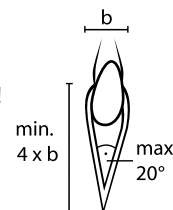

- Hooks or other lifting devices in loaded condition must not be attached in the area of sewn overlaps or at the seam of the round sling sleeve. Make sure that the seams are positioned in the straight part of the lifting device.
- Hooks should be provided with sufficient radius. The contact area of the web sling must be straight, so that the entire cross section of the sling is loaded equally. If the carrying width of flat webbing sling is below 75 mm, the radius curve of the lifting device must be at least $\frac{3}{4}$ of the width of the webbing sling.

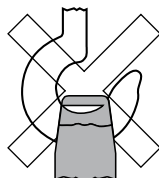

- Take care that round slings do not overlap in the crane hook. They must have sufficient space in the hook mouth as well as at the load, so they can assume their natural, flattened profile and provide even loading over the full width of the round sling.
- Flat webbing slings should be applied in such a way that they can carry the load over the full sling width. Greater angles from the vertical will strain the edges of the slings and possibly lead to breakage!
- Textile lashing equipment must be protected against sharp edges, friction and abrasion at both load and lifting device. A radius edge is classed as sharp, if it is less than the thickness of the flat webbing or round sling (in flat, loaded condition).
- Never push or place the load onto the lifting device! Never pull the load over rough surfaces or edges and do not drag from underneath a load.
- In "choke hitch" the textile sling should be positioned so that it can form a natural angle of 60° and that heat due to friction is avoided.

Never re-adjust the choke hitch and prevent heat development by friction (slipping of load). In order to lift loads with plain or slippery surface we recommend double choke hitch.

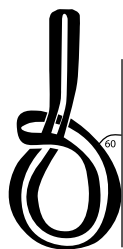

- Round slings and flat webbing slings will stretch under load by approx. 3-5%. This has to be strictly considered as it may cause abrasion resp. damages at sensible surfaces. As prevention we recommend the use of protective sleeves and edge protectors. In case of (intended) load movements during lifting operations and resulting friction, e.g. during assembling or turning of goods, the surface or edges of the load must be secured by protective sleeves or corner protectors, which will safeguard the lashing device and leave sufficient space for movement and alignment without greater friction (see dim. B in the following drawing).



- If more than one sling is used to lift a load, these should be of same type with preferably same length in order to avoid different elongation behaviour and allow carrying ability over the full width (employ smallest angle from the vertical or use spreader beam instead).
- Textile lifting equipment must be stored in a clean, dry and well ventilated area. Avoid exposure to direct sunlight and other sources of UV. Keep them away from other heat sources, chemicals, fumes and corroded surfaces as they will have a negative effect on the life expectancy of the sling. Slings should not be dried near open fires or other hot places.
- Textile slings with obvious damages, overloading or other detrimental influences must be taken out of use and may be returned to service after inspection and possible repair only.

Maintenance and repair

Inspections and tests must be performed by competent persons or specialist workshops only.

Inspections

Depending on application, textile lifting equipment must be subjected to regular inspections by competent persons, at least once per year. The inspection must be visual and extended to the following deficiencies:

- Complete and legible identity label.
- Damages by chemical influence, e.g. local soaking, chipping of yarns or heat (hardening).
- Steel links must not show deformations, grooves or reduction to the cross section of more than 10%. Check for cracks; possible welding points must be visible and not covered by the webbing.
- Inspections have to be recorded.
- Defective slings have to be taken out of service immediately and must be stored separately.

Criteria for disposal of textile lifting equipment

Textile slings must not be used any longer if e.g.

- the marking (identity label) is missing or illegible.
- detrimental impacts have occurred, e.g. overloading, shock loading, chemical influence or heat.

Flat webbing slings

















- damages of selvage, defects of the woven structure by abrasion, cuts or yarn breakages have occurred. If 10% or more of the webbing sling cross section is damaged the sling must be discarded.
- heavy deformation or melting of yarns due to heat (shiny surface and/or hardened webbing) can be recognized.
- load bearing seams are defective.

Round Slings

















- the outside (sleeve) is damaged by cuts or abrasion.
- the inside (polyester yarns) of the sling is visible.
- the seams of the sleeve are damaged.

! For information on training please see pages 4-5.

Flat webbing slings Rated capacities for different slinging methods

		WLL in kg with one webbing sling					WLL in kg with two webbing slings			
		straight pull	choke hitch	basket, angle β			straight angle β		choke hitch angle β	
				up to 7°	7°-45°	45°-60°	7°-45°	45°-60°	7°-45°	45°-60°
										
Factor		1.0	0.8	2.0	1.4	1.0	1.4	1.0	1.12	0.8
1000 kg		1000	800	2000	1400	1000	1400	1000	1120	800
2000 kg		2000	1600	4000	2800	2000	2800	2000	2240	1600
3000 kg		3000	2400	6000	4200	3000	4200	3000	3360	2400
4000 kg		4000	3200	8000	5600	4000	5600	4000	4480	3200
5000 kg		5000	4000	10000	7000	5000	7000	5000	5600	4000
6000 kg		6000	4800	12000	8400	6000	8400	6000	6720	4800
8000 kg		8000	6400	16000	11200	8000	11200	8000	8960	6400
10000 kg		10000	8000	20000	14000	10000	14000	10000	11200	8000

Round slings Rated capacities for different slinging methods

		WLL in kg with one round sling						WLL in kg with two round slings				
		straight pull	choke hitch	basket, angle β			straight angle β		choke hitch angle β			
				up to 7°	7°-45°	45°-60°	7°-45°	45°-60°	7°-45°	45°-60°		
												
Factor		1.0	0.8	2.0	1.4	1.0	0.7	0.5	1.4	1.0	1.12	0.8
1000 kg		1000	800	2000	1400	1000	700	500	1400	1000	1120	800
2000 kg		2000	1600	4000	2800	2000	1400	1000	2800	2000	2240	1600
3000 kg		3000	2400	6000	4200	3000	2100	1500	4200	3000	3360	2400
4000 kg		4000	3200	8000	5600	4000	2800	2000	5600	4000	4480	3200
5000 kg		5000	4000	10000	7000	5000	3500	2500	7000	5000	5600	4000
6000 kg		6000	4800	12000	8400	6000	4200	3000	8400	6000	6720	4800
8000 kg		8000	6400	16000	11200	8000	5600	4000	11200	8000	8960	6400
10000 kg		10000	8000	20000	14000	10000	7000	5000	14000	10000	11200	8000



Other capacities (up to 20 t) and special lengths available upon request.



Endless flat webbing sling, single ply model HSE

Made from polyester (PES), according to EN 1492-1, form A2, single ply, with capacity label.

Features

- Single ply, PU-starched, thermally fixed.
- Colour coded webbing.
- Woven tonnage stripes.
- Low weight allows easy handling.
- Protection against hand injuries.
- Protection against cargo surface damage.
- Consistent pressure distribution onto pressure- and pull sensitive loads.
- UV-resistant, eliminating material ageing or embrittlement.
- Heat resistant up to +100°C.
- Moisture-resistant fabric, thus preventing frost damage (up to approx. -40°C).
- Low elongation < 4%.

Technical data model HSE

Model	Colour code EN 1492	Capacity WLL, with one sling, straight pull kg	Capacity WLL, with one sling, basket, angle β up to 7° kg	Capacity WLL, with one sling, basket, angle β 7°- 45° kg	Capacity WLL, with one sling, basket, angle β 45°- 60° kg	Capacity WLL, with one sling, choke hitch kg	Webbing width mm
HSE-01000	violet	1000	2000	1400	1000	800	30
HSE-02000	green	2000	4000	2800	2000	1600	60
HSE-03000	yellow	3000	6000	4200	3000	2400	90
HSE-04000	grey	4000	8000	5600	4000	3200	120

Flat webbing sling, duplex construction, reinforced eyes model HBD

Made from polyester (PES), according to EN 1492-1, form B2, with reinforced eyes, duplex construction, with capacity label.



Features

- Duplex construction, PU-starched and thermally fixed.
- With reinforced eyes.
- Woven tonnage stripes.
- Low weight allows easy handling.
- Protection against hand injuries.
- Protection against cargo surface damage.
- Consistent pressure distribution onto pressure- and pull sensitive loads.
- UV-resistant, eliminating material ageing or embrittlement.
- Heat resistant up to +100°C.
- Moisture-resistant fabric, thus preventing frost damage (up to approx. -40°C).
- Low elongation < 4%.



Rapid production of special lengths is possible because of own manufacture.

Other capacities (up to 25 t) and special lengths available upon request.

Technical data model HBD

Model	Colour code EN 1492	Capacity WLL, with one sling, straight pull kg	Capacity WLL, with one sling, basket, angle β up to 7° kg	Capacity WLL, with one sling, basket, angle β 7°- 45° kg	Capacity WLL, with one sling, basket, angle β 45°- 60° kg	Capacity WLL, with one sling, choke hitch kg	Webbing width mm	Eye length approx. mm	Eye width approx. mm	Shortest possible length for special makes mm
HBD-01000	violet	1000	2000	1400	1000	800	30	300	15	750
HBD-02000	green	2000	4000	2800	2000	1600	60	350	30	1000
HBD-03000	yellow	3000	6000	4200	3000	2400	90	400	45	1000
HBD-04000	grey	4000	8000	5600	4000	3200	120	500	60	1500
HBD-05000	red	5000	10000	7000	5000	4000	150	550	75	1500
HBD-06000	brown	6000	12000	8400	6000	4800	180	600	90	2000
HBD-08000	blue	8000	16000	11200	8000	6400	240	650	120	2500
HBD-10000	orange	10000	20000	14000	10000	8000	300	900	150	2500



Webbing sling, duplex construction, steel links on both ends model HBD SN

Made from polyester (PES), according to EN 1492-1 form C2, with end links made of high quality steel, duplex construction, with capacity label.

Features

- Duplex construction, PU-starched and thermally fixed.
- With two steel D-links (non reeveable).
- Low weight allows easy handling.
- Protection against hand injuries.
- Protection against cargo surface damage.
- Consistent pressure distribution onto pressure- and pull sensitive loads.
- UV-resistant, eliminating material ageing or embrittlement.
- Heat resistant up to +100°C.
- Moisture-resistant fabric, thus preventing frost damage (up to approx. -40°C).
- Low elongation < 4%.

Technical data model HBD SN

Model	Colour code EN 1492	Capacity WLL, with one sling, straight pull kg	Capacity WLL, with one sling, basket, angle β up to 7° kg	Capacity WLL, with one sling, basket, angle β 7°- 45° kg	Capacity WLL, with one sling, basket, angle β 45°- 60° kg	Webbing width mm	Link type	Link dimension b x d x t mm
HBD-01000-SN	violet	1000	2000	1400	1000	50	SN 50	50 x 13 x 95
HBD-02000-SN	green	2000	4000	2800	2000	60	SN 60	60 x 16 x 90
HBD-03000-SN	yellow	3000	6000	4200	3000	90	SN 90	90 x 18 x 110
HBD-04000-SN	grey	4000	8000	5600	4000	120	SN 120	120 x 22 x 130
HBD-05000-SN	red	5000	10000	7000	5000	150	SN 150	150 x 26 x 170
HBD-06000-SN	brown	6000	12000	8400	6000	180	SN 180	180 x 30 x 200
HBD-08000-SN	blue	8000	16000	11200	8000	240	SN 240	240 x 32 x 230
HBD-10000-SN	orange	10000	20000	14000	10000	300	SN 300	300 x 40 x 290

Webbing sling, duplex construction, steel links on both ends model HBD SD

Made from polyester (PES), according to EN 1492-1 form Cr2 with end links made of high quality steel, duplex construction, with capacity label.

Features

- Duplex construction, PU-starched and thermally fixed.
- With steel D- and DP-links (reevable).
- Woven tonnage stripes.
- Low weight allows easy handling.
- Protection against hand injuries.
- Protection against cargo surface damage.
- Consistent pressure distribution onto pressure- and pull sensitive loads.
- UV-resistant, eliminating material ageing or embrittlement.
- Heat resistant up to +100°C.
- Moisture-resistant fabric, thus preventing frost damage (up to approx. -40°C).
- Low elongation < 4%.



Links are reevable, webbing sling also applicable for use in choke hitch.

Technical data model HBD SD

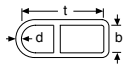
Model	Colour code EN 1492	Capacity WLL, with one sling, straight pull kg	Capacity WLL, with one sling, basket, angle β up to 7° kg	Capacity WLL, with one sling, basket, angle β 7°- 45° kg	Capacity WLL, with one sling, basket, angle β 45°- 60° kg	Capacity WLL, with one sling, choke hitch kg	Webbing width mm	Link type	Link dimension b x d x t mm 
HBD-01000-SD	violet	1000	2000	1400	1000	800	50	SN/SD 50	50 x 13 x 145
HBD-02000-SD	green	2000	4000	2800	2000	1600	60	SN/SD 60	60 x 16 x 165
HBD-03000-SD	yellow	3000	6000	4200	3000	2400	90	SN/SD 90	90 x 18 x 190
HBD-04000-SD	grey	4000	8000	5600	4000	3200	120	SN/SD 120	120 x 22 x 240
HBD-05000-SD	red	5000	10000	7000	5000	4000	150	SN/SD 150	150 x 26 x 300
HBD-06000-SD	brown	6000	12000	8400	6000	4800	180	SN/SD 180	180 x 30 x 320
HBD-08000-SD	blue	8000	16000	11200	8000	6400	240	SN/SD 240	240 x 32 x 360
HBD-10000-SD	orange	10000	20000	14000	10000	8000	300	SN/SD 300	300 x 40 x 435



Higher capacities upon request.



Round sling with duplex sleeve model RSD

Made from polyester according to EN 1492-2, with double stitchless protection sleeve, with capacity label.

Features

- With double protection sleeve, PU-starched, thermally fixed.
- Colour coding of the protective sleeve.
- Printed-on capacities.
- Woven tonnage stripes, per ton capacity 1 stripe (applies only to round slings up to 10 t).
- Low weight allows easy handling.
- Protection against hand injuries.
- Protection against cargo surface damage.
- Highly flexible and adaptable to given shapes.
- UV-resistant, eliminating material ageing or embrittlement.
- Heat resistant up to +100°C.
- Moisture-resistant fabric, thus preventing frost damage (up to approx. -40°C).

Technical data model RSD

Model	Colour code EN 1492	Capacity WLL, with one sling, straight pull kg	Capacity WLL, with one sling, basket, angle β up to 7° kg	Capacity WLL, with one sling, basket, angle β 7°- 45° kg	Capacity WLL, with one sling, basket, angle β 45°- 60° kg	Capacity WLL, with one sling, choke hitch kg	Width approx. under load mm	Thickness approx. under load mm
RSD-01000	violet	1000	2000	1400	1000	800	52	5
RSD-02000	green	2000	4000	2800	2000	1600	57	6
RSD-03000	yellow	3000	6000	4200	3000	2400	71	9
RSD-04000	grey	4000	8000	5600	4000	3200	76	9

Special lengths available upon request.

XL-Round sling model RSX

Yaletex XL-Round slings - extremely long service life, for extreme applications.

Made from polyester, according to EN 1492-2.

Features

- Long service life due to an extra strong protective sleeve, optimized woven structure.
- Easy identification of the annually required UVV tests through an additional label showing a check list.
- Colour coding of the protective sleeve.
- Printed-on capacities.
- Woven tonnage stripes.
- Low weight allows easy handling.
- Protection against hand injuries.
- Protection against cargo surface damage.
- Highly flexible and adaptable to given shapes.
- UV-resistant, eliminating material ageing or embrittlement.
- Heat resistant up to +100°C.
- Moisture-resistant fabric, thus preventing frost damage (up to approx. -40°C).
- With an extra strong single sleeve, PU-starched and thermally fixed.



! Further capacities (up to 100 t) and special lengths can be delivered on request.

Technical data model RSX

Model	Colour code EN 1492	Capacity kg	Min. breaking load kg	Tonnage stripes	Flat width approx. mm	Flat height approx. mm	Shortest length approx. mm
RSX-01000	violet	1000	7000	1	52	10	500
RSX-02000	green	2000	14000	2	57	10	500
RSX-03000	yellow	3000	21000	3	71	15	500
RSX-04000	grey	4000	28000	4	76	15	1000
RSX-05000	red	5000	35000	5	86	20	1000
RSX-06000	brown	6000	42000	6	96	20	2000
RSX-08000	blue	8000	56000	8	112	25	2000
RSX-10000	orange	10000	70000	10	130	30	2000

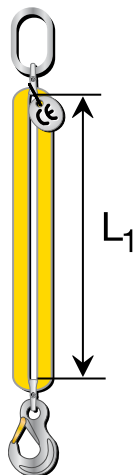

Round sling assembly 1-legged model RSG

According to EN 1492-2
with high tensile forgings according to EN 1677.

Technical data model RSG 1-legged

Model	Capacity WLL straight pull kg
RSG-01000-1-SIKA	1000
RSG-02000-1-SIKA	2000
RSG-03000-1-SIKA	3000
RSG-05000-1-SIKA	5000
RSG-08000-1-SIKA	8000

! Flat webbing sling assembly upon request.

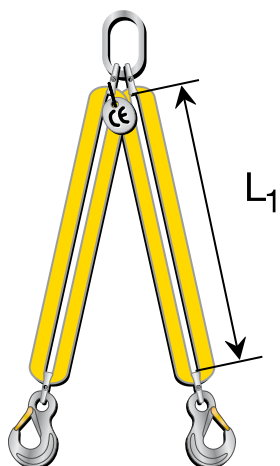

Round sling assembly 2-legged model RSG

According to EN 1492-2
with high tensile forgings according to EN 1677.

Technical data model RSG 2-legged

Model	Capacity WLL, straight pull, angle β 0°-45° kg	Capacity WLL, straight pull, angle β 45°-60° kg
RSG-01000-2-SIKA	1400	1000
RSG-02000-2-SIKA	2800	2000
RSG-03000-2-SIKA	4200	3000
RSG-05000-2-SIKA	7000	5000
RSG-08000-2-SIKA	11200	8000

Round sling assembly 3-legged model RSG

According to EN 1492-2
with high tensile forgings according to EN 1677.

Technical data model RSG 3-legged

Model	Capacity WLL, straight pull, angle β 0°-45° kg	Capacity WLL, straight pull, angle β 45°-60° kg
RSG-01000-3-SIKA	2100	1500
RSG-02000-3-SIKA	4200	3000
RSG-03000-3-SIKA	6300	4500
RSG-05000-3-SIKA	10500	7500
RSG-08000-3-SIKA	16800	12000

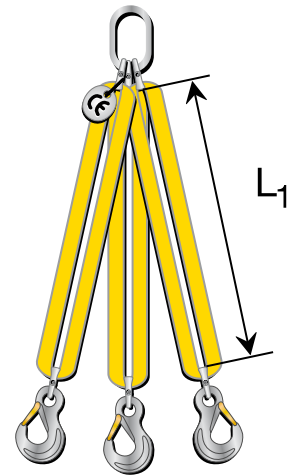

Standard length 1-3 m.

Attention: The mentioned lengths refer to the useable length L1 of the round sling.

Round sling assembly 4-legged model RSG

According to EN 1492-2
with high tensile forgings according to EN 1677.

Technical data model RSG 4-legged

Model	Capacity WLL, straight pull, angle β 0°-45° kg	Capacity WLL, straight pull, angle β 45°-60° kg
RSG-01000-4-SIKA	2100	1500
RSG-02000-4-SIKA	4200	3000
RSG-03000-4-SIKA	6300	4500
RSG-05000-4-SIKA	10500	7500
RSG-08000-4-SIKA	16800	12000

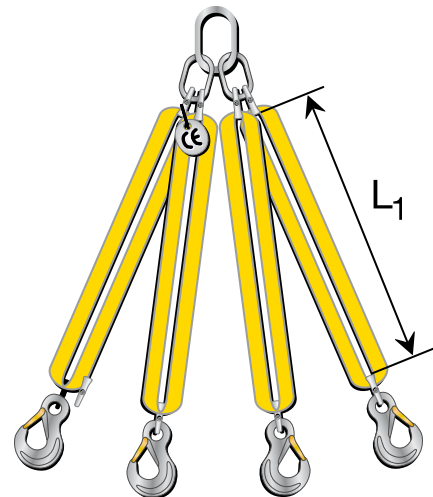

Other sizes upon request.

Textile Lifting Slings Round sling assembly

Round sling assembly Rated capacities for different slinging methods



Factor	1-legged		2-legged				3-legged and 4-legged	
	straight pull	choke hitch	straight pull	choke hitch	straight pull	choke hitch	straight pull	
	angle β 0°- 45°		angle β 0°- 45°		angle β 45°- 60°		0°- 45°	45°- 60°
	1.0	0.8	1.4	1.1	1.0	0.8	2.1	1.5
1000 kg	1000	800	1400	1100	1000	800	2100	1500
2000 kg	2000	1600	2800	2200	2000	1600	4200	3000
3000 kg	3000	2400	4200	3300	3000	2400	6300	4500
5000 kg	5000	4000	7000	5500	5000	4000	10500	7500
8000 kg	8000	6400	11200	8800	8000	6400	16800	12000

PU-protection sleeve, single and double-sided model PU-SC

Made from cut resistant polyurethane

With inner fabric insert to ease sliding of the sleeve on the webbing. Standard length 2 and 4 m.

Double PU sleeves cannot be fitted subsequently on webbing slings with steel links. If required, state sleeve length when placing the webbing sling order.



PU-protection sleeve single-sided,
model PU-SC-1

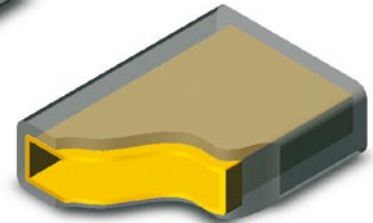

PU-protection sleeve double-sided,
model PU-SC-2

Technical data model PU SC, single-sided

Model	EAN-No. 4025092*	Webbing width mm	Dimensions outside x inside mm	Height mm
PU-SC1-030	*357906	30	50 x 40	22
PU-SC1-050	*352680	50	70 x 60	22
PU-SC1-060	*352697	60	80 x 70	22
PU-SC1-090	*352710	90	110 x 100	22
PU-SC1-120	*357951	120	145 x 135	22
PU-SC1-150	*357876	150	170 x 160	22
PU-SC1-180	*357869	180	200 x 190	22
PU-SC1-240	*357883	240	260 x 250	31
PU-SC1-300	*357890	300	330 x 320	31

Technical data model PU SC, double-sided

Model	EAN-No. 4025092*	Webbing width mm	Dimensions outside x inside mm	Height mm
PU-SC2-030	*357944	30	50 x 40	22
PU-SC2-050	*352741	50	70 x 60	22
PU-SC2-060	*352758	60	80 x 70	22
PU-SC2-090	*352772	90	110 x 100	22
PU-SC2-120	*352802	120	145 x 135	22
PU-SC2-150	*352826	150	170 x 160	22
PU-SC2-180	*357913	180	200 x 190	22
PU-SC2-240	*357920	240	260 x 250	31
PU-SC2-300	*357937	300	330 x 320	31

Lengths over 4 m upon request.



PU-edge protector model PU-KSW

Made from cut resistant polyurethane

With slots to allow easy attachment and fixing on the round sling.

Technical data model PU KSW

Model	EAN-No. 4025092*	Diameter mm	Length mm	Suitable for round slings up to WLL kg
PU-KSW-30	*357067	30	80	3000
PU-KSW-50	*357074	50	125	5000



Round sleeve model PU-SG

With fabric insert and PU-coating

Economical solution to protect webbing slings and round slings against wear caused by abrasion.

**Not suitable for protection
against sharp edges.**

Technical data model PU SG

Model	EAN-No. 4025092*	Width approx. mm	Length mm	Diameter mm	Suitable for round slings up to WLL kg
PU-SG-040	*352840	60	1000	40	2000
PU-SG-063	*352857	95	1000	63	3000
PU-SG-075	*352864	115	1000	75	6000
PU-SG-090	*352871	140	1000	90	8000
PU-SG-110	*352888	170	1000	110	10000
PU-SG-150	*352895	230	1000	150	15000

PU-coating, single and double-sided model PU-FB

Made from transparent polyurethane

Extremely wear and cut resistant. The coating is permanently fixed to the webbing and cannot be lost during usage.

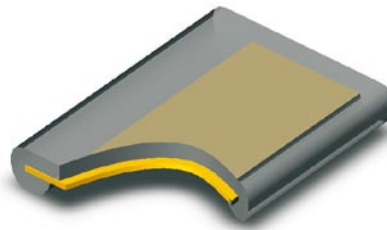

Coating single-sided,
model PU-FB 1

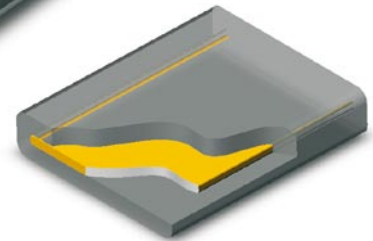

Coating double-sided,
model PU-FB 2

Technical data model PU FB, single-sided

Model	EAN-No. 4025092*	Webbing width mm	Width mm	Length mm
PU-FB1-030	*358620	30	40	1000
PU-FB1-050	*352529	50	60	1000
PU-FB1-060	*352536	60	70	1000
PU-FB1-090	*352543	90	100	1000
PU-FB1-120	*352550	120	130	1000
PU-FB1-150	*352567	150	160	1000
PU-FB1-180	*352574	180	190	1000
PU-FB1-240	*352581	240	250	1000
PU-FB1-300	*352598	300	310	1000

Technical data model PU FB, double-sided

Model	EAN-No. 4025092*	Webbing width mm	Width mm	Length mm
PU-FB2-030	*358637	30	40	1000
PU-FB2-050	*352604	50	60	1000
PU-FB2-060	*352611	60	70	1000
PU-FB2-090	*352628	90	100	1000
PU-FB2-120	*352635	120	130	1000
PU-FB2-150	*352642	150	160	1000
PU-FB2-180	*352659	180	190	1000
PU-FB2-240	*352666	240	250	1000
PU-FB2-300	*352673	300	310	1000

General information about load security

The varying forces, which can result in slipping, rolling, tilting or even lift-off of loads during transport, are regularly underestimated. Possible consequences are e.g. that the vehicle gets out of control, the driving cab is damaged, the vehicle even overturns and the falling load endangers others!

The common assumption that very heavy loads do not require lashing security, is a fatal error. Lashing of loads may be performed by competent users (trained in theory and practice) only.

Some basic rules about load security with ratchet lashings

- Depending on the cargo, consideration shall be given to select an appropriate vehicle with adequate structures and lashing points.
- The load centre of gravity should be as low as possible and ideally positioned according to the load distribution plan of the vehicle.
- The permissible gross weight and loads per axle must not be exceeded.
- The load should be stored as close and low as possible and should not leave free space between load, front wall or side walls. Free spaces between the outer walls and the load should be stuffed where possible.
- Depending on the type of cargo, the driving speed should be conform to the road and traffic situation as well as to the driving quality of the vehicle.
- Adverse friction values between cargo and loading area (oily metals, wet areas etc.) will considerably increase the requirement for a correct security of the load. Slip restraining mats will contribute to achieve a more economic and efficient load lashing security.
- Unstable cargo is very susceptible to tilting and in most cases has to be lashed extensively (calculation against slipping and tilting).
- Positive load lashing (e.g. supporting the cargo at front and side walls or with wedges or scantlings fixed on the loading platform) will contribute substantially to the stabilisation of the cargo and to reduction of additional lashing requirement.

Forces on cargo loads (according to EN 12195)

Truck and trailer loading (road transport) - Acceleration coefficients

During road transport the heaviest stresses on the load security equipment will occur during braking, lift-off of the load by vibration and impact as well as centrifugal forces in narrow curves.

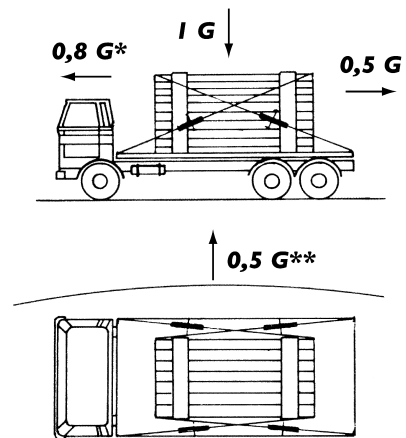

* The value for the longitudinal acceleration in combined traffic (lorry and/or trailer during rail transport) has to be calculated with 1G.

** 0.7 for tilting of instable cargo loads

Lashing methods

Over top lashing

Over top lashing consists of tensioning the lashings to the tension force so as to increase the friction force at the contact surface of the load to avoid any sliding of the load. Influence factors are the dimensions of the load, the acceleration values, the dynamic friction factors as well as the lashing angle. The calculation of lashing forces will give the required tension force of the lashing devices.

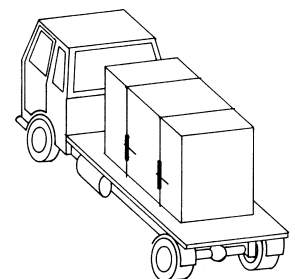

For information on training please see pages 4-5.

This user information presents a general overview regarding the application of web lashings and does not substitute the existing operating instructions for specific products!

Lashing operations with textile lashing equipment may be carried out by competent users (trained in theory and practice) only. When operated correctly, our textile lashings offer the highest degree of safety in line with long life expectancy and avoid damage to material and people.

Limitations of use

Temperature

Textile lashings in accordance with this part of the European standard EN 12195 are suitable for the following temperature areas:

- 40°C up to +80°C for polypropylene (PP)
- 40°C up to +100°C for polyamide (PA)
- 40°C up to +120°C for polyester (PES)

These temperature areas may change in chemical environments. In this case consult the manufacturer or supplier for advice.

A change of the ambient temperature during transport may influence the tension force of the textile lashing. The tension force should be checked after entering warm regions.

Chemicals

The resistance against chemical influences varies depending on the materials used for the textile lashing. Please observe the advice of the manufacturer, if the textile lashings are subjected to chemicals. Also consider that the effect of the chemical influence will increase with rising temperatures. The resistance of synthetic fibre against chemical influences is summarised as follows:

- Polyamides are resistant against alkaline but affected by mineral acids.
- Polyester is resistant against mineral acids but affected by alkaline solutions.
- Polypropylene is hardly affected by acids and alkaline and is suited for applications that require high resistance against chemicals (except some organic solvents).
- Harmless acid or alkaline solutions may be concentrated by evaporation and lead to damages. Affected textile lashings have to be taken out of service immediately, thoroughly rinsed in cold water and dried in the open-air.

Operation in danger zones

During loading and unloading observe low hanging aerial contact lines.

Application advices

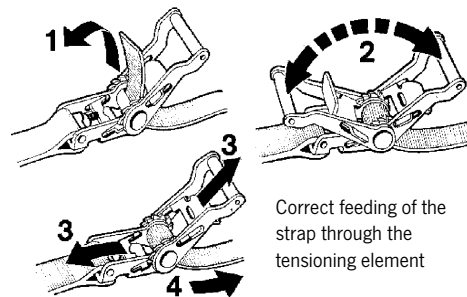

- Selection and use of textile lashings depend on the required tensioning force as well as the mode of application and type of cargo to be lashed. Size, form and weight of the cargo determine the correct choice in addition to the intended usage. For stability reasons, at least two lashing systems should be used for over top lashing and two pairs of lashing straps for diagonal lashing.
- The selected web lashing must be strong enough for the intended job and have the correct length for the type of lashing. Always consider adequate lashing practice: Attachment and removal of lashings should be planned before the start of the journey. In case of longer trips, partial unloadings must be considered. The number of lashings must be calculated as per EN 12195-1:2000. Over top lashing requires systems, which are labelled STF for over top lashing.
- On account of different characteristics and change of length under load, different lashings (e.g. lashing chains and web lashings) may not be used for lashing the same load. When using additional fittings or lashing devices, make sure that these correspond to the existing web lashing.
- During operation, flat hooks must be in contact with the full width of the hook mouth.



- Releasing of the lashing: Prior to releasing, make sure that the load stands safely (even without safety device) and does not endanger the operator by falling. Before departure check whether additional lashings will be required for further transportation after partial unloading has occurred.
- This is also true for lashing elements which permit safe removal.
- Prior to unloading, the lashings must be released to an extent that the load stands freely.
- Make sure that the web lashing will not be damaged by the edges of the cargo. A visual inspection should be standard procedure before and after each usage.
- Only use textile lashings with legible identity labels.
- Textile lashings must not be overloaded: The max. hand force of 500 N (50 daN on the label; 1 daN = approx. 1 kg) may be applied with one hand only. Do not use cheater bars or levers unless they are part of the lashing element.
- Knotted textile lashings must not be used.
- Damages to the identity labels should be avoided by keeping them away from the edges of the cargo.
- Textile lashings should be protected against friction and abrasion and damages by sharp edges by application of protective sleeves and/or edge protectors.

Labelling

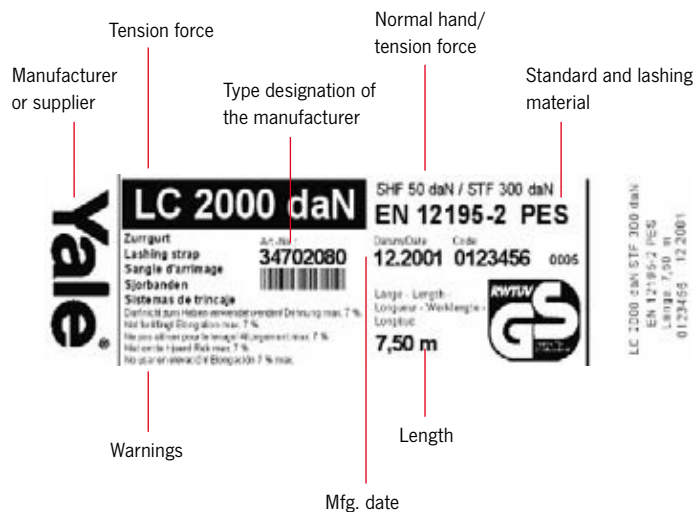

Maintenance and repair

Textile lashings may only be repaired if provided with legible identity labels. In case of accidental contact with chemicals, the web lashing has to be withdrawn from service and the manufacturer or supplier consulted for advice.

Criteria for disposal of textile lashings

Textile lashings must be withdrawn from service and returned for repair to the manufacturer in case of obvious defects. The following points are signs of possible damages:

Textile lashings

- Cracks, cuts, notches and breaks in the load bearing strands and seams as well as deformations by heat.

Tensioning devices and fittings

- Deformations, cracks, obvious signs of wear and corrosion.

The quantity of textile lashings has to be calculated according to EN 12195-1:2000

Only use lashing systems for over top lashing which show STF on the label. For easy identification of the required quantity of textile lashings or existing lashings needed for the cargo to be lashed refer to the following table, which has been calculated with friction coefficients of $\mu = 0.2$, $\mu=0.4$ and $\mu = 0.6$ at various angles of elevation a.

- The calculation refers to situations with min. two, however max. ten textile lashings.
- Whenever possible, always use a slip resistant mat with a certified friction coefficient of 0.6!
- Always operate with the highest possible angle of elevation and lash as steep as possible.
- The friction coefficients are applicable for clean and dry surfaces, well covered from frost, ice and snow. In case of moisture refer to the direct lashing method or double the amount of textile lashings!

Friction factors according to EN 12195-1:2000 table 5:

Combination of materials in the contact surface	Friction factor μ	when using a slip resistant mat
Cut timber against fabric base laminate/plywood	0.5	0.6
Cut timber against grooved aluminium	0.4	0.6
Cut timber against steel sheets	0.4	0.6
Cut timber against shrink films	0.3	0.6
Shrink films against fabric base laminate/plywood	0.4	0.6
Shrink films against grooved aluminium	0.4	0.6
Shrink films against steel sheets	0.4	0.6
Shrink films against shrink films	0.4	0.6
Cardboard box against cardboard box	0.5	0.6
Cardboard box against wooden pallet	0.5	0.6
Big bags against wooden pallet	0.4	0.6
Flat steel bars against cut timber	0.5	0.6
Unpainted corrugated sheets against cut timber	0.5	0.6
Painted corrugated sheets against cut timber	0.4	0.6
Unpainted corrugated sheets against unpainted corrugated sheets	0.3	0.6
Painted corrugated sheets against painted corrugated sheets	0.2	0.6

Number of required textile lashings for different cargo weights

- at different friction factors
- at different angles

Tension force of ratchet 300 daN at standard hand force of 50 daN according to EN 12195.

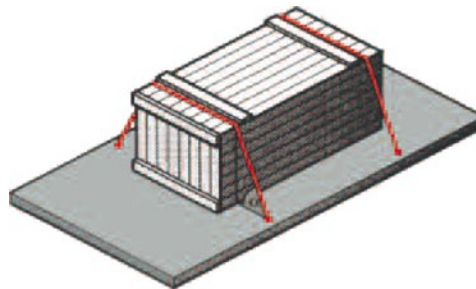

Applicable to textile lashings model ZGR-50-2500 with LC 2500 daN and model ZGR-50-2000 with LC 2000 daN

Cargo weight	Friction factor μ 0.20			Friction factor μ 0.40 Angle			Friction factor μ 0.60		
	30°	60°	90°	30°	60°	90°	30°	60°	90°
1000 kg		10	9	7	4	3	3	2	2
2000 kg					8	7	6	3	3
3000 kg						10	9	5	4
4000 kg								7	6
5000 kg								8	7
6000 kg								10	9
7000 kg									10
8000 kg									
9000 kg									
10000 kg									

Cells without indication require more than 10 web lashings. In these cases a reasonable cargo securing can only be obtained by direct lashing method. Obstruction forces by cargo boards and form-fit locking devices have not been considered.



Cambuckle lashing model ZGK-25-125

according to EN 12195-2
25 mm - lashing capacity LC 125 daN.

Features

- Standard tension force STF 30 daN at standard hand force SHF 50 daN.
- Standard lengths 4 m and 6 m.

Other lengths upon request.

Technical data model ZGK

Model	EAN-No. 4025092*	Description	Permissible ratchet force LC daN	Webbing width mm	Webbing length mm
ZGK-25-125-1	*352505	1 piece	125	25	4000
ZGK-25-125-1	*352512	1 piece	125	25	6000



Ratchet lashing model ZGR-25-250

according to EN 12195-2

25 mm - lashing capacity LC 250 daN.

Features

- Standard tension force STF 50 daN at standard hand force SHF 50 daN.
- Standard lengths 4 m and 6 m.



! Other lengths upon request.

Technical data model ZGR-25-250

Model	EAN-No. 4025092*	Description	Permissible ratchet force LC daN	Webbing width mm	Webbing length mm
ZGR-25-250-1	*352017	1 piece	250	25	4000
ZGR-25-250-1	*352024	1 piece	250	25	6000
ZGR-25-250-2-SPH	*352383	2 part - with claw hook	250	25	4000
ZGR-25-250-2-SPH	*352390	2 part - with claw hook	250	25	6000

Ratchet lashing model ZGR-25-500

according to EN 12195-2

25 mm - lashing capacity LC 500 daN.

Features

- Standard tension force STF 100 daN at standard hand force SHF 50 daN.
- Standard lengths 4 m and 6 m.



! Other lengths upon request.

Technical data model ZGR-25-500

Model	EAN-No. 4025092*	Description	Permissible ratchet force LC daN	Webbing width mm	Webbing length mm
ZGR-25-500-1	*352031	1 piece	500	25	4000
ZGR-25-500-1	*352048	1 piece	500	25	6000
ZGR-25-500-2-SPH	*352406	2 part - with claw hook	500	25	4000
ZGR-25-500-2-SPH	*352413	2 part - with claw hook	500	25	6000

Lashing Equipment Ratchet lashings



Ratchet lashing model ZGR-35-1000

according to EN 12195-2

35 mm - lashing capacity LC 1000 daN.

Features

- Standard tension force STF 150 daN at standard hand force SHF 50 daN.
- Standard lengths 6 m and 8 m.



GKH - with twisted
snap hook



SPH - with claw hook



KLH - with chassis hook

Other lengths upon request.



Technical data model ZGR-35-1000

Model	EAN-No. 4025092*	Description	Permissible ratchet force LC daN	Webbing width mm	Webbing length mm
ZGR-35-1000-1	*352055	1 piece	1000	35	6000
ZGR-35-1000-1	*352062	1 piece	1000	35	8000
ZGR-35-1000-2-GKH	*352147	2 part - with snap hook	1000	35	6000
ZGR-35-1000-2-GKH	*352154	2 part - with snap hook	1000	35	8000
ZGR-35-1000-2-KLH	*352208	2 part - with chassis hook	1000	35	6000
ZGR-35-1000-2-KLH	*352215	2 part - with chassis hook	1000	35	8000
ZGR-35-1000-2-SPH	*352420	2 part - with claw hook	1000	35	6000
ZGR-35-1000-2-SPH	*352437	2 part - with claw hook	1000	35	8000

Ratchet lashing model ZGR-50-2000

according to EN 12195-2

50 mm - lashing capacity LC 2000 daN.

Features

- Standard tension force STF 300 daN at standard hand force SHF 50 daN.
- Standard lengths 8 m and 10 m.



GKH - with twisted snap hook



SPH - with claw hook



KLH - with chassis hook

Other end fittings (hooks) and individual prints on webbing are available upon request.

Technical data model ZGR-50-2000

Model	EAN-No. 4025092*	Description	Permissible ratchet force LC daN	Webbing width mm	Webbing length mm
ZGR-50-2000-1	*352086	1 piece	2000	50	8000
ZGR-50-2000-1	*352079	1 piece	2000	50	10000
ZGR-50-2000-2-GKH	*352178	2 part - with snap hook	2000	50	8000
ZGR-50-2000-2-GKH	*352161	2 part - with snap hook	2000	50	10000
ZGR-50-2000-2-KLH	*352239	2 part - with chassis hook	2000	50	8000
ZGR-50-2000-2-KLH	*352222	2 part - with chassis hook	2000	50	10000
ZGR-50-2000-FE-KLH	*356640	Fixed end with ratchet	2000	50	500
ZGR-50-2000-2-SPH	*352451	2 part - with claw hook	2000	50	8000
ZGR-50-2000-2-SPH	*352444	2 part - with claw hook	2000	50	10000
ZGR-50-2000-FE-SPH	*356657	Fixed end with ratchet	2000	50	500

Other lengths upon request.

Lashing Equipment Ratchet lashings



Ratchet lashing model ZGR-50-2500

according to EN 12195-2

50 mm - lashing capacity LC 2500 daN.

Features

- Standard tension force STF 300 daN at standard hand force SHF 50 daN.
- Standard lengths 8 m and 10 m.



GKH - with twisted
snap hook



SPH - with claw hook



KLH - with chassis hook

**Other end fittings (hooks) and individual prints
on webbing are available upon request.**

Technical data model ZGR-50-2500

Model	EAN-No. 4025092*	Description	Permissible ratchet force LC daN	Webbing width mm	Webbing length mm
ZGR-50-2500-1	*352109	1 piece	2500	50	8000
ZGR-50-2500-1	*352093	1 piece	2500	50	10000
ZGR-50-2500-2-GKH	*352192	2 part - with snap hook	2500	50	8000
ZGR-50-2500-2-GKH	*352185	2 part - with snap hook	2500	50	10000
ZGR-50-2500-2-KLH	*352253	2 part - with chassis hook	2500	50	8000
ZGR-50-2500-2-KLH	*352246	2 part - with chassis hook	2500	50	10000
ZGR-50-2500-FE-KLH	*356664	Fixed end with ratchet	2500	50	500
ZGR-50-2500-2-SPH	*352475	2 part - with claw hook	2500	50	8000
ZGR-50-2500-2-SPH	*352468	2 part - with claw hook	2500	50	10000
ZGR-50-2500-FE-SPH	*356671	Fixed end with ratchet	2500	50	500

Other lengths upon request.

Ratchet lashing model ZGR-75-5000

according to EN 12195-2

75 mm - lashing capacity LC 5000 daN.

Features

- Standard tension force STF 500 daN at standard hand force SHF 50 daN.
- Standard lengths 2 m and 4 m.



! Other hooks upon request.



SPH - with claw hook

Technical data model ZGR-75-5000

Model	EAN-No. 4025092*	Description	Permissible ratchet force LC daN	Webbing width mm	Webbing length mm
ZGR-75-5000-1	*352116	1 piece	5000	75	2000
ZGR-75-5000-1	*352123	1 piece	5000	75	4000
ZGR-75-5000-2-SPH	*352482	2 part - with claw hook	5000	75	2000
ZGR-75-5000-2-SPH	*352499	2 part - with claw hook	5000	75	4000

! Other lengths upon request.



Ratchet lashing model ZGR-XL-50-2000

according to EN 12195-2

50 mm - lashing capacity LC 2000 daN.

Features

- Standard tension force STF 500 daN at standard hand force SHF 50 daN.
- Long lever ratchet with precise interlocking.
- Device for controlled release.
- Standard lengths 8 m and 10 m.

Other end fittings (hooks) and individual prints on webbing are available upon request.



Long lever ratchet for controlled release.

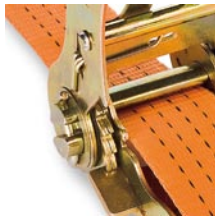

GKH - with twisted snap hook



SPH - with claw hook



KLH - with chassis hook

Technical data model ZGR-XL-50-2000

Model	EAN-No. 4025092*	Description	Permissible ratchet force LC daN	Webbing width mm	Webbing length mm
ZGR-XL-50-2000-1	*360579	1 piece	2000	50	8000
ZGR-XL-50-2000-1	*360562	1 piece	2000	50	10000
ZGR-XL-50-2000-2-GKH	*360593	2 part - with snap hook	2000	50	8000
ZGR-XL-50-2000-2-GKH	*360586	2 part - with snap hook	2000	50	10000
ZGR-XL-50-2000-2-KLH	*360616	2 part - with chassis hook	2000	50	8000
ZGR-XL-50-2000-2-KLH	*360609	2 part - with chassis hook	2000	50	10000
ZGR-XL-50-2000-2-SPH	*360630	2 part - with claw hook	2000	50	8000
ZGR-XL-50-2000-2-SPH	*360623	2 part - with claw hook	2000	50	10000

Other lengths upon request.

Also available with long lever ratchet, however, without device for controlled release.

Please indicate when ordering.

Ratchet lashing model ZGR-XL-50-2500

according to EN 12195-2

50 mm - lashing capacity LC 2500 daN.

Features

- Standard tension force STF 500 daN at standard hand force SHF 50 daN.
- Long lever ratchet with precise interlocking.
- Device for controlled release.
- Standard lengths 8 m and 10 m.



Other end fittings (hooks) and individual prints on webbing are available upon request.



Long lever ratchet for controlled release.

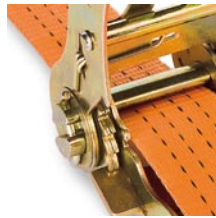

GKH - with twisted snap hook



SPH - with claw hook



KLH - with chassis hook

Technical data model ZGR-XL-50-2500

Model	EAN-No. 4025092*	Description	Permissible ratchet force LC daN	Webbing width mm	Webbing length mm
ZGR-XL-50-2500-1	*360654	1 piece	2500	50	8000
ZGR-XL-50-2500-1	*360647	1 piece	2500	50	10000
ZGR-XL-50-2500-2-GKH	*360678	2 part - with snap hook	2500	50	8000
ZGR-XL-50-2500-2-GKH	*360661	2 part - with snap hook	2500	50	10000
ZGR-XL-50-2500-2-KLH	*360692	2 part - with chassis hook	2500	50	8000
ZGR-XL-50-2500-2-KLH	*360685	2 part - with chassis hook	2500	50	10000
ZGR-XL-50-2500-2-SPH	*360715	2 part - with claw hook	2500	50	8000
ZGR-XL-50-2500-2-SPH	*360708	2 part - with claw hook	2500	50	10000

Other lengths upon request.

Also available with long lever ratchet, however, without device for controlled release. Please indicate when ordering.



Truck lashing model ZGR-SLE

Made from polyester, according to EN 12195-2

With rail anchor suitable for fixing rails.

Technical data model ZGR-SLE

Model	EAN-No. 4025092*	Description	Permissible ratchet force LC daN	Webbing width mm	Length fixed end LGF mm	Length loose end LGL mm
ZGR-50-1000-2-SLE	*356527	2 part	1000	50	1000	3000

Other lengths upon request.



Container lashing model ZGR-CZR

Made from polyester, according to EN 12195-2

Container lashing with ratchet and round sling with reinforced loop and protection hose.

Technical data model ZGR-CZR

Model	EAN-No. 4025092*	Description	Permissible ratchet force LC daN	Webbing width mm	Round sling 3000 kg, useable length mm	Length fixed end LGF mm	Length loose end LGL mm
ZGR-50-2500-2-CZR	*356534	2 part	2500	50	1250	500	500

Wheel lashing model ZGR-DSPH

Made from polyester,
according to EN 12195-2

With D-ring and ratchet and claw hook.



Technical data model ZGR-DSPH

Model	EAN-No. 4025092*	Description	Permissible ratchet force LC daN	Webbing width mm	Webbing length mm
ZGR-35-1000-1-DSPH	*356541	1 piece	1000	35	2300

Ratchet base model ZGZB-RU

Manufactured from cut resistant polyurethane.
Can also be used as edge protector.



Technical data model ZGZB

Model	EAN-No. 4025092*	For webbing width mm
ZGZB-RU-PU-50	*352901	35 - 50
ZGZB-RU-PU-75	*352918	75



Edge protector model ZGZB-KS

Edge protector for lashing sensitive loads (cardboard boxes).

Technical data model ZGZB

Model	EAN-No. 4025092*	For webbing width mm
ZGZB-KS-PP-50	*352949	50



Edge protector profile

Manufactured from polypropylene or recycled cardboard, to protect edges of loads.

Length up to 4 m.

Technical data model ZGZB

Model	EAN-No. 4025092*	Dimensions mm
ZGZB-KSP-PP	*356688	190 x 190 x 20

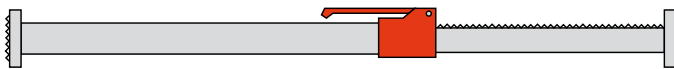

Load stabilizer bar model ZGZB-KBR

Load stabilizer bars are used to secure loads between bulkheads or between floor and ceiling.

Technical data model ZGZB

Model	EAN-No. 4025092*	Weight kg	Clamping range from - up to mm
ZGZB-KBR-3100	*352994	7.5	2300 - 3100

Slip restraining mats model ZGZB-ARM

Manufactured from compressed rubber granulate to achieve a defined friction coefficient of $\mu = 0.6$.

Even if an emergency stop or evasive action is being taken – the cargo trucks or train wagons must not move. But only in very few cases the vehicle structure alone will offer sufficient load security.

For this reason, slip restraining devices should belong to the standard equipment of every professional transport.

Slip restraining mats will decrease the danger which emanates from plain loading platforms. They will reduce the required total pre-tensioning forces during over top lashing of loads and will contribute – together with the textile lashings – that the loads will form a single unit with the vehicle or wagon.

The slip restraining effect will benefit especially those products, which do not stand a high surface pressure.

The dangers resulting from incorrect load lashing practices are often underestimated. Acceleration forces in standard driving situations are close to the dead weight of the load!

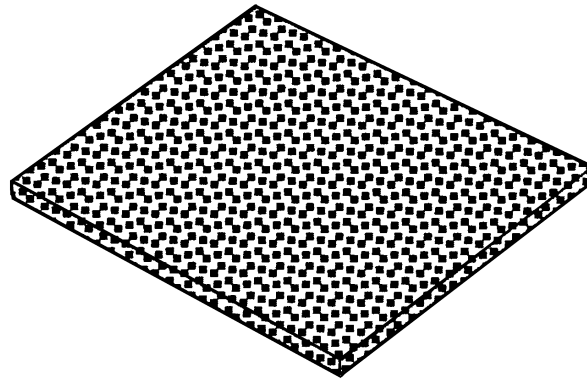

! Further dimensions on request.

Technical data model ZGZB

Model	EAN-No. 4025092*	Dimensions mm
ZGZB-ARM-250-8	*352963	1000 x 250 x 8

The friction force FW of a slip restraining mat impedes load displacement and is physically explained as follows:

$$FW = m \times G$$

G = Weight force

m = Friction value

The difference between inertial force F and friction force FW is called securing force FS.

$$FS = F - FW$$

The securing force FS is the strength which has to be absorbed by the safety devices.





Load binders model RLSP

Pulling force 4000 - 10600 daN

The load binder is a universal tool to restrain and secure loads and freight. Manual operation of the binder lever extends or retracts the threaded spindles. Tension is upheld by the self-locking threads.

The load binder is fitted with shortening hooks for direct attachment to chains or with clevis ends for use with existing fastening devices.

Technical data model RLSP

Model	EAN-No. 4025092*	Description	Pulling force LC daN	Weight kg
RLSP-08-ÖÖ	*457880	Clevis	4000	3.6
RLSP-10-ÖÖ	*457897	Clevis	6300	3.6
RLSP-13-ÖÖ	*457903	Clevis	10600	3.8
RLSP-08-HH	*457859	Shortening hooks	4000	4.5
RLSP-10-HH	*457866	Shortening hooks	6300	5.5
RLSP-13-HH	*457873	Shortening hooks	10600	8.4

Dimensions model RLSP

Model	RLSP-08-ÖÖ	RLSP-10-ÖÖ	RLSP-13-ÖÖ	RLSP-08-HH	RLSP-10-HH	RLSP-13-HH
Chain size min., mm	8	10	13	8	10	13
B1, mm	250	250	250	250	250	250
B2 min., mm	360	360	366	588	630	722
B2 max., mm	510	510	516	738	780	872
Diameter E, mm	20	20	25	-	-	-
L, mm	360	360	360	360	360	360

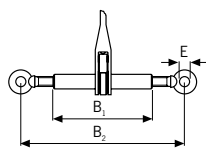

Model RLSP - Load binder with protection against unscrewing. Clevis acc. to EN 12195-3 on both ends.

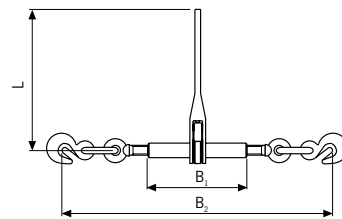

Model RLSP - Load binder with protection against unscrewing. Clevis or shortening hook acc. to EN 12195-3 on both ends.

Weld-on hooks model ASH

Capacity 1000 - 8000 kg

Weld-on hooks model ASH are universal attachments for use on trucks, excavators, low loaders and spreader beams, etc. The forged safety latch has high lateral stability and an ergonomic shape. Every weld-on hook has an identification number so that its history can be traced back through forging to the origin of the material.

The hook can be welded without any special preparation, e.g. prewarming.

The hook and safety latch are epoxy resin coated for added corrosion protection, the return spring is made from stainless steel.



Technical data model ASH

Model	EAN-No. 4025092*	Capacity kg	Weight kg
ASH 1	*453073	1000	0.5
ASH 3	*453011	3000	1.3
ASH 5	*453028	5000	2.4
ASH 8	*453035	8000	3.6

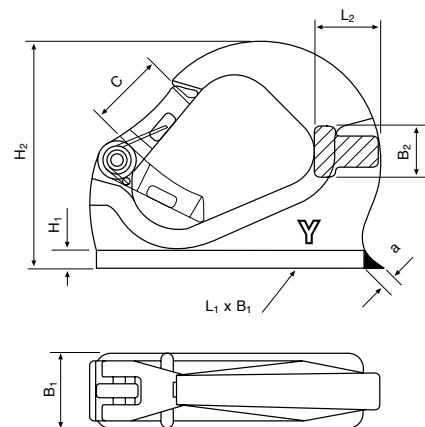

Dimensions model ASH

Model	ASH 1	ASH 3	ASH 5	ASH 8
Seam density, a	4	7	5	7
L1 x B1, mm	90 x 25	130 x 35	160 x 45	170 x 50
B2, mm	17	24	30	40
C, mm	24	47	37	47
H1, mm	6	10	10	10
H2, mm	76	132	132	138
L2, mm	22	47	47	50

Model ASH